

1

Kit 5181

TOYOTA Prius, 5-dr Hatchback, 04-08 / *04-09

*North America



ISO 11154-E

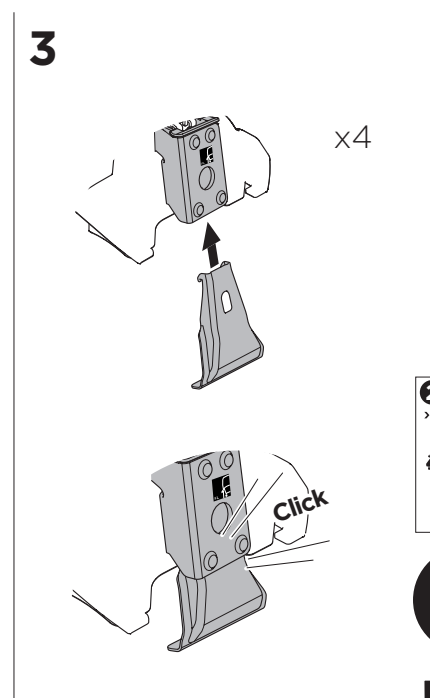
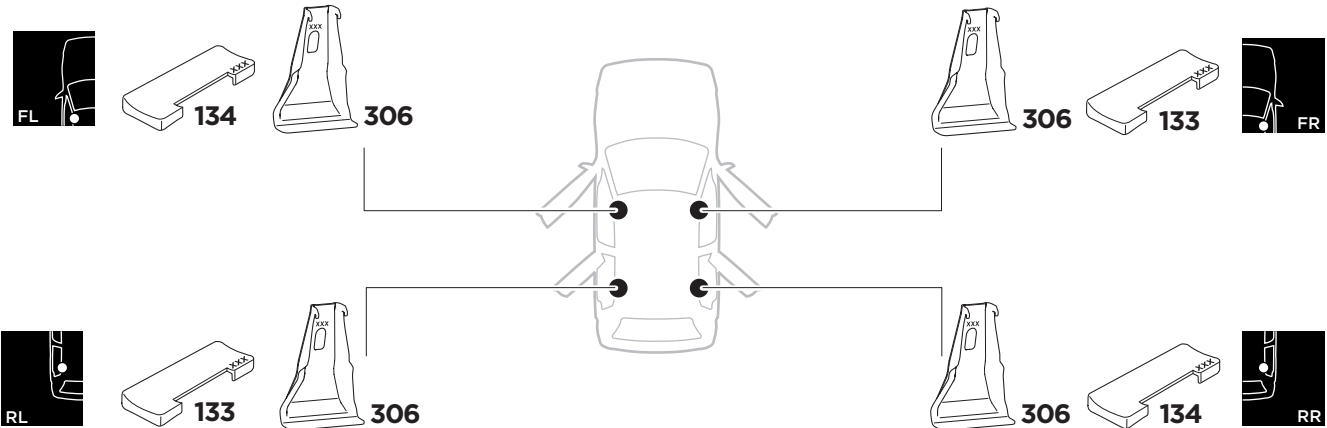
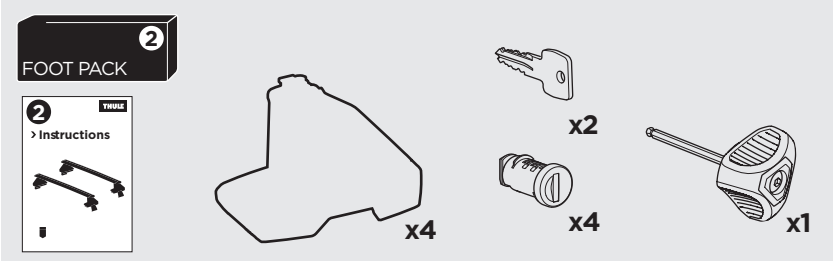
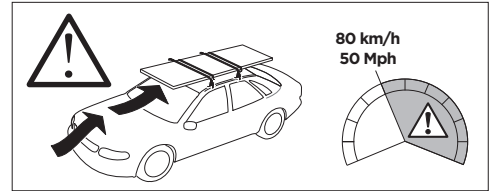
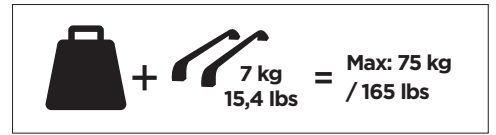
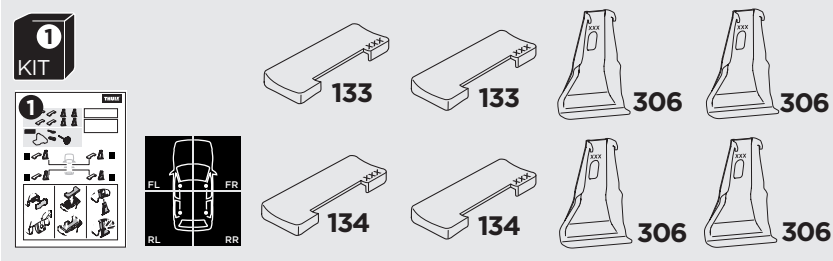



THULE WingBar Evo	THULE WingBar Edge	THULE WingBar	THULE SquareBar	Evo X (scale)	Edge X (scale)
TOYOTA Prius, 5-dr Hatchback, 04-08/*04-09				41	O
THULE ProBar	THULE SlideBar				X (mm/inch)
TOYOTA Prius, 5-dr Hatchback, 04-08/*04-09				1061 mm / 41 3/4"	

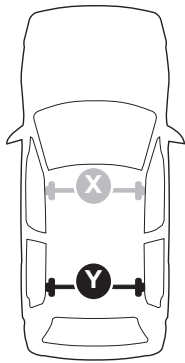

THULE WingBar Evo	THULE WingBar Edge	THULE WingBar	THULE SquareBar	Evo Y (scale)	Edge Y (scale)
TOYOTA Prius, 5-dr Hatchback, 04-08/*04-09				39	A
THULE ProBar	THULE SlideBar				Y (mm/inch)
TOYOTA Prius, 5-dr Hatchback, 04-08/*04-09				1041 mm / 41"	

	W (mm/inch)	Z (mm/inch)
TOYOTA Prius, 5-dr Hatchback, 04-08/*04-09	650 mm / 25 5/8"	350 mm / 13 3/4"

